

# Card Guides

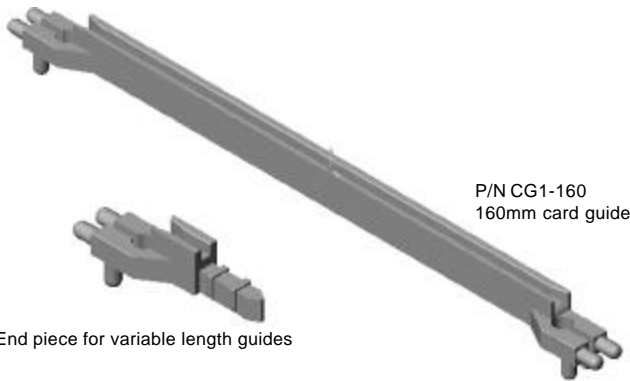

Specially designed card guides provide easy installation and repositioning, without special tools. Material is durable glass-filled Noryl. Package contains 12 guides. Secure installation by spring loaded retainer ledge on front strut and vertical insertion into rear strut holes.

Part No.	Description	Card Thickness	Description
CG1-160/12	160mm	.062	Glass filled Noryl
CG1-220/12	220mm	.062	Glass filled Noryl
CG1-280U/12	280mm	.062	Black anodized aluminum w/ end
CG1-340U/12	340mm	.062	Black anodized aluminum w/ end
CG1-400U/12	400mm	.062	Black anodized aluminum w/ end



Aluminum - "U" type - Cut to desired lengths.  
Assembly of 2 end pieces & cut aluminum extrusion

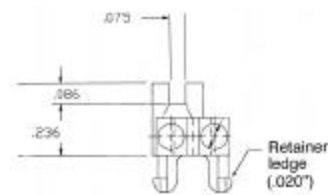

# Extrusions

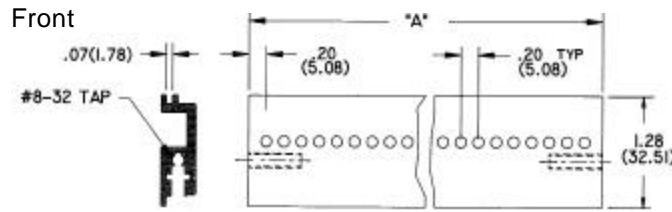

All extrusions available in any length

Part No.	HP	A
5250236-84	84	17.00" (431.8)
5250236-63	63	12.80" (325.8)
5250236-42	42	8.60" (218.4)
5250236-21	21	4.40" (11.8)

Screw #80884106    Pack of 25    Pack of 12 order: HD94

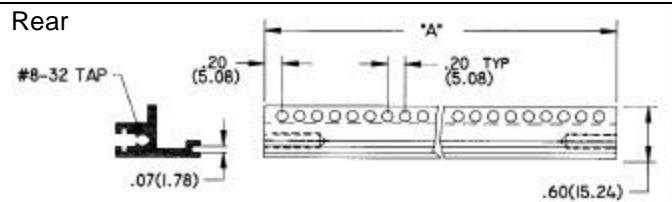

Part No.	HP	A
5250238-84	84	17.00" (431.8)
5250238-63	63	12.80" (325.8)
5250238-42	42	8.60" (218.4)
5250238-21	21	4.40" (11.8)

Screw #80884106    Pack of 25    Pack of 12 order: HD94

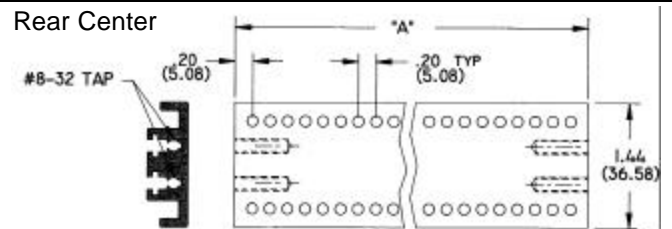

Part No.	HP	A
5250237-84	84	17.00" (431.8)
5250237-63	63	12.80" (325.8)
5250237-42	42	8.60" (218.4)
5250237-21	21	4.40" (11.8)

Screw #80884106    Pack of 25    Pack of 12 order: HD94

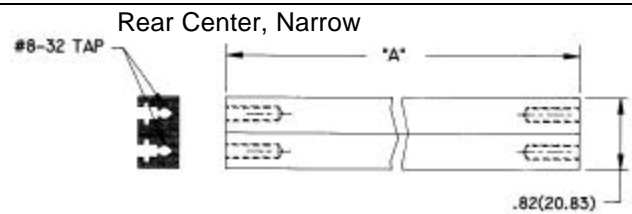

Part No.	HP	A
5250229-84	84	17.00" (431.8)
5250229-63	63	12.80" (325.8)
5250229-42	42	8.60" (218.4)
5250229-21	21	4.40" (11.8)

Screw #80884106    Pack of 25    Pack of 12 order: HD94

Subracks

## Side Panels



### Universal

- Versatile side-panel with flanges
- Strut mounting holes positioned on 12mm centers for maximum flexibility



### With Flanges

- Provides front rack mounting



### Flangeless

- For maximum economy of space

Vector Europackaging Side Panels feature .080" brushed aluminum construction with clear irridite finish. There are three versions available.

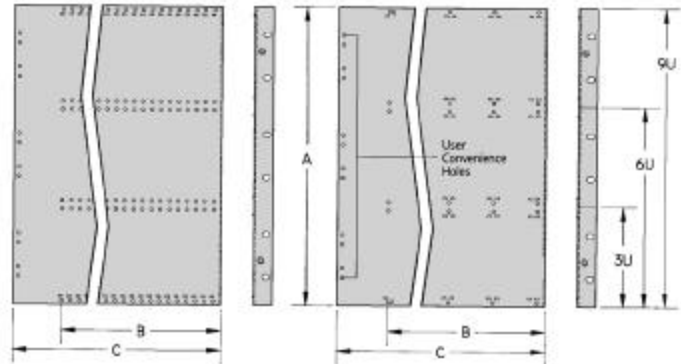

Part No.	Size x Dim B	Description	B	C
5260475	3U x 160mm	Flangeless	6.57"	9.27"
5260251	3U x 160mm	W/Flanges	6.57"	9.27"
5260476	3U x 220mm	Flangeless	8.93"	11.63"
5260252	3U x 220mm	W/Flanges	8.93"	11.63"
5260477	3U x 280mm	Flangeless	11.3"	14.00"
5260264	3U x 280mm	W/Flanges	11.3"	14.00"
5260267	6U x 160mm	Flangeless	6.57"	9.27"
5260204	6U x 160mm	W/Flanges	6.57"	9.27"
5260266	6U x 220mm	Flangeless	8.93"	11.63"
5260212	6U x 220mm	W/Flanges	8.93"	11.63"
5260472	6U x 280mm	Flangeless	11.3"	14.00"
5260289	6U x 280mm	Universal	11.3"	14.00"
5260247	6U x 280mm	W/Flanges	11.3"	14.00"
5260473	6U x 340mm	Flangeless	13.66"	16.36"
5260239	6U x 340mm	W/Flanges	13.66"	16.36"
5260474	6U x 400mm	Flangeless	16.02"	18.72"
5260309	6U x 400mm	Universal	16.02"	18.72"
5260243	6U x 400mm	W/Flanges	16.02"	18.72"
5260467	9U x 160mm	Flangeless	6.57"	9.27"
5260249	9U x 160mm	W/Flanges	6.57"	9.27"
5260468	9U x 220mm	Flangeless	8.93"	11.63"
5260311	9U x 220mm	Universal	8.93"	11.63"
5260248	9U x 220mm	W/Flanges	8.93"	11.63"
5260469	9U x 280mm	Flangeless	11.3"	14.00"
5260291	9U x 280mm	Universal	11.3"	14.00"
5260294	9U x 280mm	W/Flanges	11.3"	14.00"
5260470	9U x 340mm	Flangeless	13.66"	16.36"
5260240	9U x 340mm	W/Flanges	13.66"	16.36"
5260471	9U x 400mm	Flangeless	16.02"	18.72"
5260308	9U x 400mm	Universal	16.02"	18.72"
5260299	9U x 400mm	W/Flanges	16.02"	18.72"

Material: 5052-H5, .090" thk

Finish: Clear irridite